

**M12 male 0° / RJ45 male 0° shielded Ethernet**

PUR 2x2xAWG22 shielded gn UL/CSA+drag chain 6m

Male straight – male straight

M12 – RJ45, 4-pole

D-coded

shielded

Ethernet CAT5

Further cable lengths on request.

Plastic housings with good resistance against chemicals and oils.

The resistance to aggressive media should be individually tested for your application. Further details on request.

**Illustration**

Product may differ from Image

**Approvals**

\* only for products with UL/CSA approved cable

**More Info**

EtherNet/IP

**Form**

Form 44711

**Cables**

No./diameter of wires	2 × 2 × 0.34 mm <sup>2</sup>
Wire isolation	PE (wh, ye, bl, or)
C-track properties	2 Mio.
Material (jacket)	PUR (UL/CSA)
Outer Ø	7.4 mm ±5%
Bend radius (moving)	12 × outer Ø
Temperature range (fixed)	-40...+80 °C
Temperature range (mobile)	-30...+70 °C

Cable identification	659
Approval (cable)	UL (AWM-Style 20234/10988), CSA; CE
Cable weight [g/m]	89,10
Material (wire)	Cu wire, bare
Resistor (core)	max. 55 $\Omega$ /km (20 °C)
Diameter (core)	2 x 2 x 0.34 mm <sup>2</sup>
AWG	similar to AWG 22
Material (wire isolation)	PE
Wire-Ø incl. isolation	1.4 mm $\pm$ 5%
Color/numbering of wires	wh, ye, bl, or
Shield	yes
	min. 85%
Material (jacket)	PUR
Outer-Ø (jacket)	7.4 mm $\pm$ 5%
Color (jacket)	green
chemical resistance	good resistance to oil, gasoline and chemicals
thermal resistance	flame retardant
Nominal voltage	600 V
Temperature range (fixed)	-40...+80 °C
Temperature range (mobile)	-30...+70 °C
Bend radius (fixed)	5 x outer Ø
Bend radius (moving)	12 x outer Ø
No. of bending cycles (C-track)	max. 2 Mio. (25 °C)
Traversing distance (C-track)	max. 5 m (horizontal)
Travel speed (C-track)	max. 3.3 m/s
Acceleration (C-track)	max. 2 m/s <sup>2</sup>
Jacket Color	green

#### Technical Data

Operating voltage	max. 60 V DC
Operating voltage (only UL listed)	max. 30 V DC
Rated surge voltage	1.0 kV
Operating current per contact	max. 1.5 A (20 °C)
Material group	IEC 60664-1, category I
Transfer parameters	CAT5, Class D (ISO/IEC 11801:2002), (EN 50173-1)
Transfer rate	up to 100 Mbit/s full duplex
Coding	M12, D-coded
Locking of ports	Screw thread (M12x1 mm) recommended torque 0.6 Nm, self-securing
Compression gland	M12 (SW13)
Protection	IP67 (M12) - IP20 (RJ45)
Locking material	Zinc die casting, matte nickel plated
Material	PUR
suitable for corrugated tube (internal Ø)	without

#### General data

Standards	DIN EN 61076-2-101 (M12)
Pollution Degree	3
Temperature range	-25...+85 °C, depending on cable quality

#### Commercial data

country of origin	DE
customs tariff number	85444290

EAN	4048879669214
eClass	27061801
Packaging unit	1

**Sketch**

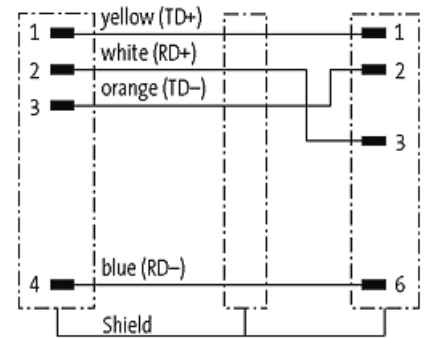
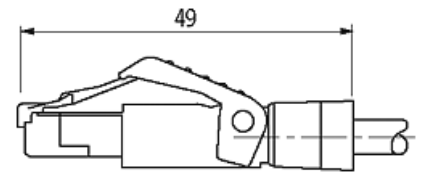

Male

Male

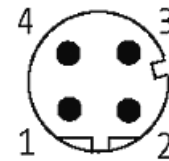

Product may differ from Image